

# HANGING BANNER 8FT SQUARE 24IN



## Product Features

The Square Hanging Banner is a must have at your next trade show. These extra large hanging banners are produced from high quality fabric and enable you to be seen from practically anywhere at your trade show.

Graphic Size 384"W x 26"H  
(includes 2 inches of bleed for height)

Display Size 8' Deep x 8'Wx 24" H

## Finishing

Hem with zipper

Printing Material Fabric

## Construction

All aluminum frame construction

## Weights - Dimensions

Shipping Weight 28 lbs

Shipping Dimensions 60" x 15" x 9"













## Graphic Specification

384"W x 26"H (includes 2 inches of bleed for height)

## Graphic Turnaround Time

Standard : 10 business days

## Parts List

	
(10) Chain	(48) Spring
	
(4) Small Tube	(8) Corner Connector
	
(16) Large Tube	
	
(4) Curved Stabilizer	
	
(1) Nylon Travel Bag	
	
(8) Tube Connector	(4) Eye Hook
	
(12) Large Screw	(10) Hook Loop Lock
	
(1) Screw Tightener	(1) Cable - 12 M

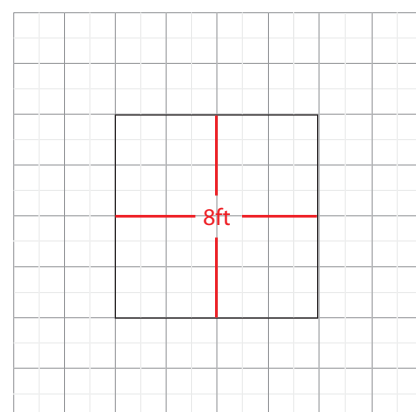

The box represents 16'x16' booth.

# HANGING BANNER 8FT SQUARE 32IN



## Product Features

The Square Hanging Banner is a must have at your next trade show. These extra large hanging banners are produced from high quality fabric and enable you to be seen from practically anywhere at your trade show.

Graphic Size 384"W x 34"H  
(includes 2 inches of bleed for height)

Display Size 8' Deep x 8'Wx 32" H

## Finishing

Hem with zipper

Printing Material Fabric

## Construction

All aluminum frame construction

## Weights - Dimensions

Shipping Weight 30 lbs

Shipping Dimensions 60"x 15"x 9"











## Graphic Specification

384"W x 34"H (includes 2 inches of bleed for height)

## Graphic Turnaround Time

Standard : 10 business days

## Parts List

	
(10) Chain	(48) Spring
	
(4) Small Tube	(8) Corner Connector
	
(16) Large Tube	
	
(4) Curved Stabilizer	
	
(1) Nylon Travel Bag	
	
(8) Tube Connector	(4) Eye Hook
	
(12) Large Screw	(10) Hook Loop Lock
	
(1) Screw Tightener	(1) Cable - 12 M

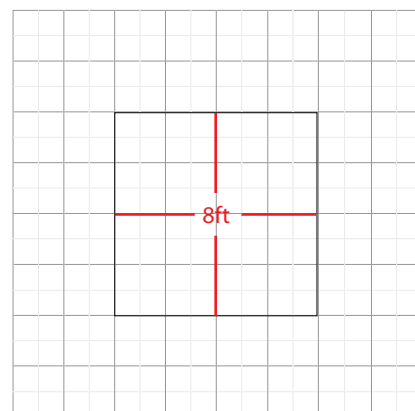

The box represents 16'x16'

# HANGING BANNER 8FT SQUARE 36IN



## Product Features

The Square Hanging Banner is a must have at your next trade show. These extra large hanging banners are produced from high quality fabric and enable you to be seen from practically anywhere at your trade show.

Graphic Size 384"W x 38"H  
(includes 2inches of bleed for height)

Display Size 8' Deep x 8'Wx 36" H

## Finishing

Hem with zipper

Printing Material Fabric

## Construction

All aluminum frame construction

## Weights - Dimensions

Shipping Weight 32 lbs

Shipping Dimensions 60" x 15" x 9"











## Graphic Specification

384"W x 38"H (includes 2inches of bleed for height)

## Graphic Turnaround Time

Standard : 10 business days

## Parts List

	
(10) Chain	(48) Spring
	
(4) Small Tube	(8) Corner Connector
	
(16) Large Tube	
	
(4) Curved Stabilizer	
	
(1) Nylon Travel Bag	
	
(8) Tube Connector	(4) Eye Hook
	
(12) Large Screw	(10) Hook Loop Lock
	
(1) Screw Tightener	(1) Cable - 12 M

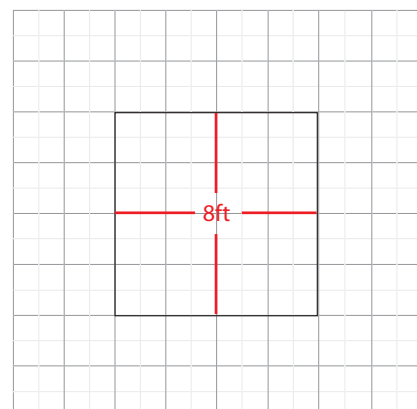

The box represents 16'x16' booth.

# HANGING BANNER 8FT SQUARE IN



## Product Features

The Square Hanging Banner is a must have at your next trade show. These extra large hanging banners are produced from high quality fabric and enable you to be seen from practically anywhere at your trade show.

Graphic Size 384"W x 44"H  
(includes 2 inches of bleed for height)

Display Size 8' Deep x 8'Wx 42" H

## Finishing

Hem with zipper

Printing Material Fabric

## Construction

All aluminum frame construction

## Weights - Dimensions

Shipping Weight 34 lbs

Shipping Dimensions 60" x 15" x 9"

## Graphic Specification

384"W x 44"H (includes 2 inches of bleed for height)

## Graphic Turnaround Time

Standard : 10 business days

## Parts List

	
(10) Chain	(48) Spring
	
(4) Small Tube	(8) Corner Connector
	
(16) Large Tube	
	
(4) Curved Stabilizer	
	
(1) Nylon Travel Bag	
	
(8) Tube Connector	(4) Eye Hook
	
(12) Large Screw	(10) Hook Loop Lock
	
(1) Screw Tightener	(1) Cable - 12 M

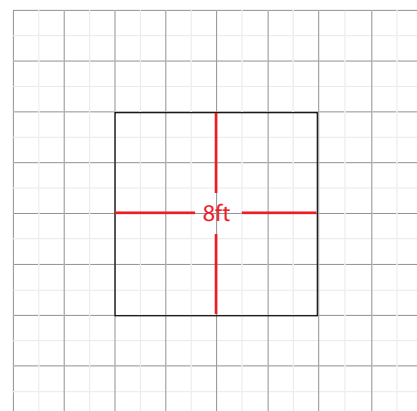

The box represents 16'x16' booth.

# HANGING BANNER 8FT SQUARE 48IN



## Product Features

The Square Hanging Banner is a must have at your next trade show. These extra large hanging banners are produced from high quality fabric and enable you to be seen from practically anywhere at your trade show.

Graphic Size 384"W x 50"H  
(includes 2 inches of bleed for height)

Display Size 8' Deep x 8'Wx 48" H

## Finishing

Hem with zipper

Printing Material Fabric

## Construction

All aluminum frame construction

## Weights - Dimensions

Shipping Weight 31 lbs

Shipping Dimensions 60" x 15" x 9"













## Graphic Specification

384"W x 50"H (includes 2 inches of bleed for height)

## Graphic Turnaround Time

Standard : 10 business days

## Parts List

	
(10) Chain	(48) Spring
	
(4) Small Tube	(8) Corner Connector
	
(16) Large Tube	
	
(4) Curved Stabilizer	
	
(1) Nylon Travel Bag	
	
(8) Tube Connector	(4) Eye Hook
	
(12) Large Screw	(10) Hook Loop Lock
	
(1) Screw Tightener	(1) Cable - 12 M

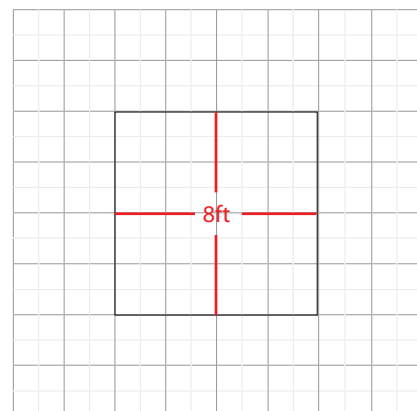

The box represents 16'x16'

# HANGING BANNER 16 FT SQUARE 16 IN



## Product Features

The Square Hanging Banner is a must have at your next trade show. These extra large hanging banners are produced from high quality fabric and enable you to be seen from practically anywhere at your trade show.

Graphic Size 480"W x 26"H  
(includes 2 inches of bleed for height)

Display Size 10' Deep x 10'W x 24" H

## Finishing

Hem with zipper

Printing Material Fabric

## Construction

All aluminum frame construction

## Weights - Dimensions

Shipping Weight 35 lbs

Shipping Dimensions 61"x 15"x 9"

## Graphic Specification

480"W x 26"H (includes 2 inches of bleed for height)

## Graphic Turnaround Time

Standard : 10 business days

## Parts List

	
(10) Chain	(56) Spring
	
(4) Small Tube	(8) Corner Connector
	
(16) Large Tube	
	
(8) Curved Stabilizer	
	
(1) Nylon Travel Bag	
	
(8) Tube Connector	(4) Eye Hook
	
(20) Large Screw	(10) Hook Loop Lock
	
(1) Screw Tightener	(1) Cable - 13.5 M

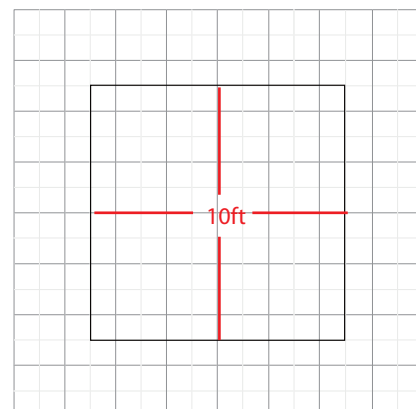

The box represents 16'x16' booth.

# HANGING BANNER FT SQUARE 3 IN



## Product Features

The Square Hanging Banner is a must have at your next trade show. These extra large hanging banners are produced from high quality fabric and enable you to be seen from practically anywhere at your trade show.

Graphic Size 480"W x 34"H  
(includes 2 inches of bleed for height)

Display Size 10' Deep x 10'Wx 32"H

## Finishing

Hem with zipper

Printing Material Fabric

## Construction

All aluminum frame construction

## Weights - Dimensions

Shipping Weight 37 lbs

Shipping Dimensions 61"x 15"x 9"

## Graphic Specification

480"W x 34"H (includes 2 inches of bleed for height)

## Graphic Turnaround Time

Standard : 10 business days

## Parts List

	
(10) Chain	(56) Spring
	
(4) Small Tube	(8) Corner Connector
	
(16) Large Tube	
	
(8) Curved Stabilizer	
	
(1) Nylon Travel Bag	
	
(8) Tube Connector	(4) Eye Hook
	
(20) Large Screw	(10) Hook Loop Lock
	
(1) Screw Tightener	(1) Cable - 13.5 M

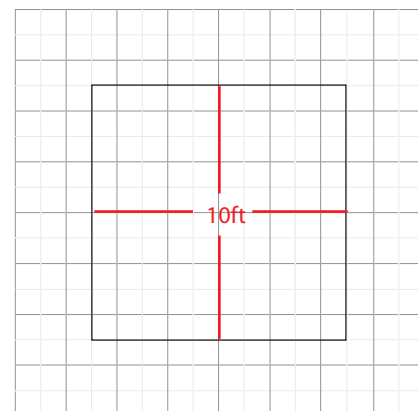

The box represents 16'x16' booth.

# HANGING BANNER

# FT SQUARE 36IN



### Product Features

The Square Hanging Banner is a must have at your next trade show. These extra large hanging banners are produced from high quality fabric and enable you to be seen from practically anywhere at your trade show.

Graphic Size 480"W x 38"H  
(includes 2inches of bleed for height)

Display Size 10' Deep x 10'Wx 36" H

### Finishing

Hem with zipper

Printing Material Fabric

### Construction

All aluminum frame construction

### Weights - Dimensions

Shipping Weight 39 lbs

Shipping Dimensions 61"x 15"x 9"

### Graphic Specification

480"W x 38"H (includes 2inches of bleed for height)

### Graphic Turnaround Time

Standard : 10 business days

### Parts List

	
(10) Chain	(56) Spring
	
(4) Small Tube	(8) Corner Connector
	
(16) Large Tube	
	
(8) Curved Stabilizer	
	
(1) Nylon Travel Bag	
	
(8) Tube Connector	(4) Eye Hook
	
(20) Large Screw	(10) Hook Loop Lock
	
(1) Screw Tightener	(1) Cable - 13.5 M

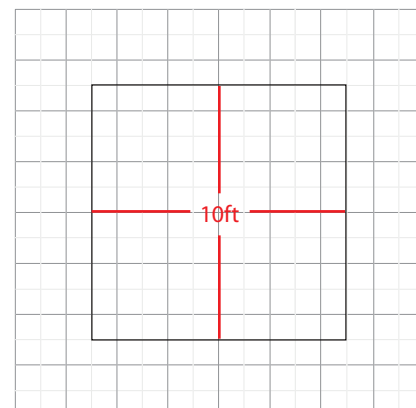

The box represents 16'x16' booth.

# HANGING BANNER 10 FT SQUARE IN



## Product Features

The Square Hanging Banner is a must have at your next trade show. These extra large hanging banners are produced from high quality fabric and enable you to be seen from practically anywhere at your trade show.

Graphic Size 480"W x 44"H  
(includes 2inches of bleed for height)

Display Size 10' Deep x 10'Wx 42"H

## Finishing

Hem with zipper

Printing Material Fabric

## Construction

All aluminum frame construction

## Weights - Dimensions

Shipping Weight 41 lbs

Shipping Dimensions 61"x 15"x 9"













## Graphic Specification

480"W x 44"H (includes 2inches of bleed for height)

## Graphic Turnaround Time

Standard : 10 business days

## Parts List

	
(10) Chain	(56) Spring
	
(4) Small Tube	(8) Corner Connector
	
(16) Large Tube	
	
(8) Curved Stabilizer	
	
(1) Nylon Travel Bag	
	
(8) Tube Connector	(4) Eye Hook
	
(20) Large Screw	(10) Hook Loop Lock
	
(1) Screw Tightener	(1) Cable - 13.5 M

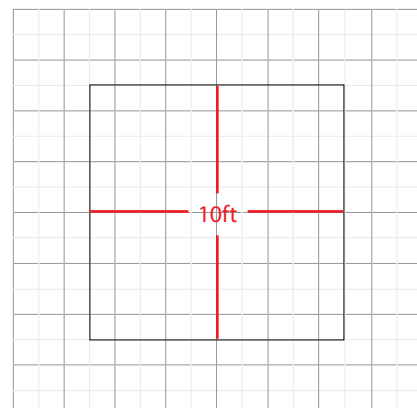

The box represents 16'x16' booth.

# HANGING BANNER 16 FT SQUARE 8 IN



## Product Features

The Square Hanging Banner is a must have at your next trade show. These extra large hanging banners are produced from high quality fabric and enable you to be seen from practically anywhere at your trade show.

Graphic Size 480"W x 50"H  
(includes 2 inches of bleed for height)

Display Size 10' Deep x 10'Wx 48" H

## Finishing

Hem with zipper

Printing Material Fabric

## Construction

All aluminum frame construction

## Weights - Dimensions

Shipping Weight 43 lbs

Shipping Dimensions 61" x 15" x 9"













## Graphic Specification

480"W x 50"H (includes 2 inches of bleed for height)

## Graphic Turnaround Time

Standard : 10 business days

## Parts List



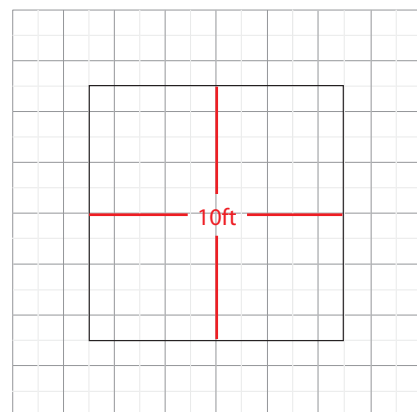









	
(10) Chain	(56) Spring
	
(4) Small Tube	(8) Corner Connector
	
(16) Large Tube	
	
(8) Curved Stabilizer	
	
(1) Nylon Travel Bag	
	
(8) Tube Connector	(4) Eye Hook
	
(20) Large Screw	(10) Hook Loop Lock
	
(1) Screw Tightener	(1) Cable - 13.5 M



The box represents 16'x16' booth.

# HANGING BANNER 12 FT SQUARE 12 IN



Parts List	
	
(10) Chain	(56) Spring
	
(4) Small Tube	(8) Corner Connector
	
(16) Large Tube	
	
(8) Curved Stabilizer	
	
(1) Nylon Travel Bag	
	
(8) Tube Connector	(4) Eye Hook
	
(20) Large Screw	(10) Hook Loop Lock
	
(1) Screw Tightener	(1) Cable - 15 M

## Product Features

The Square Hanging Banner is a must have at your next trade show. These extra large hanging banners are produced from high quality fabric and enable you to be seen from practically anywhere at your trade show.

Graphic Size	576"W x 26"H (includes 2inches of bleed for height)
Display Size	12' Deep x 12'Wx 24" H

## Finishing

Hem with zipper

Printing Material	Fabric
-------------------	--------

## Construction

All aluminum frame construction

## Weights - Dimensions

Shipping Weight	41 lbs
Shipping Dimensions	72"x 17"x 9"

## Graphic Specification

576"W x 26"H (includes 2inches of bleed for height)

## Graphic Turnaround Time

Standard : 10 business days

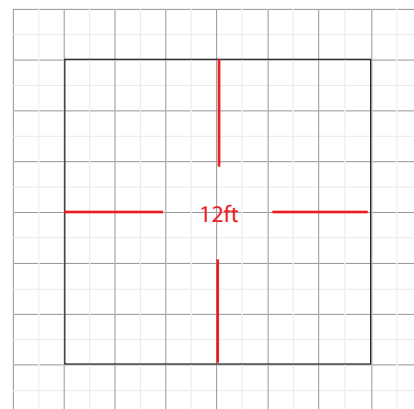

The box represents 16'x16' booth.

# HANGING BANNER FT SQUARE 3 IN



## Product Features

The Square Hanging Banner is a must have at your next trade show. These extra large hanging banners are produced from high quality fabric and enable you to be seen from practically anywhere at your trade show.

Graphic Size 576"W x 34"H  
(includes 2inches of bleed for height)

Display Size 12' Deep x 12'W x 32" H

## Finishing

Hem with zipper

Printing Material Fabric

## Construction

All aluminum frame construction

## Weights - Dimensions

Shipping Weight 43 lbs

Shipping Dimensions 72" x 17" x 9"





## Graphic Specification

576"W x 34"H(includes 2inches of bleed for height)

## Graphic Turnaround Time

Standard : 10 business days

## Parts List

	
(10) Chain	(56) Spring
	
(4) Small Tube	(8) Corner Connector
	
(16) Large Tube	
	
(8) Curved Stabilizer	
	
(1) Nylon Travel Bag	
	
(8) Tube Connector	(4) Eye Hook
	
(20) Large Screw	(10) Hook Loop Lock
	
(1) Screw Tightener	(1) Cable - 15 M

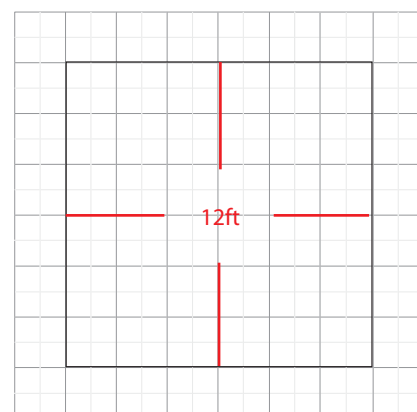

The box represents 16'x16' booth.

# HANGING BANNER FT SQUARE 36IN



## Product Features

The Square Hanging Banner is a must have at your next trade show. These extra large hanging banners are produced from high quality fabric and enable you to be seen from practically anywhere at your trade show.

Graphic Size	576"W x 38"H (includes 2inches of bleed for height)
Display Size	12' Deep x 12'W x 36" H

## Finishing

Hem with zipper

Printing Material	Fabric
-------------------	--------

## Construction

All aluminum frame construction

## Weights - Dimensions

Shipping Weight	45 lbs
Shipping Dimensions	72"x 17"x 9"













## Graphic Specification

576"W x 38"H (includes 2inches of bleed for height)

## Graphic Turnaround Time

Standard : 10 business days

## Parts List

	
(10) Chain	(56) Spring
	
(4) Small Tube	(8) Corner Connector
	
(16) Large Tube	
	
(8) Curved Stabilizer	
	
(1) Nylon Travel Bag	
	
(8) Tube Connector	(4) Eye Hook
	
(20) Large Screw	(10) Hook Loop Lock
	
(1) Screw Tightener	(1) Cable - 15 M

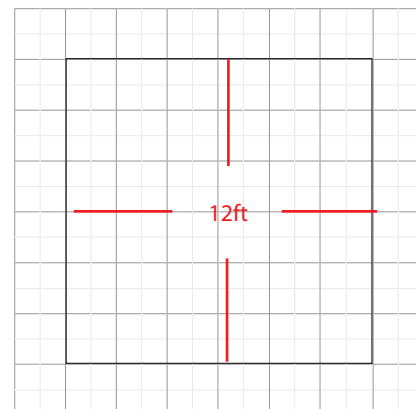

The box represents 16'x16' booth.

# HANGING BANNER 12 FT SQUARE IN



## Product Features

The Square Hanging Banner is a must have at your next trade show. These extra large hanging banners are produced from high quality fabric and enable you to be seen from practically anywhere at your trade show.

Graphic Size 576"W x 44"H  
(includes 2 inches of bleed for height)

Display Size 12' Deep x 12'W x 42" H

## Finishing

Hem with zipper

Printing Material Fabric

## Construction

All aluminum frame construction

## Weights - Dimensions

Shipping Weight 47 lbs

Shipping Dimensions 72" x 17" x 9"



## Graphic Specification

576"W x 44"H (includes 2 inches of bleed for height)

## Graphic Turnaround Time

Standard : 10 business days

## Parts List

	
(10) Chain	(56) Spring
	
(4) Small Tube	(8) Corner Connector
	
(16) Large Tube	
	
(8) Curved Stabilizer	
	
(1) Nylon Travel Bag	
	
(8) Tube Connector	(4) Eye Hook
	
(20) Large Screw	(10) Hook Loop Lock
	
(1) Screw Tightener	(1) Cable - 15 M

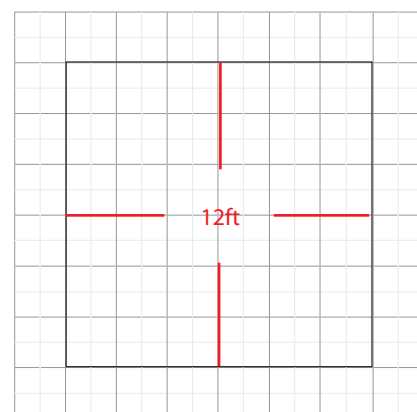

The box represents 16'x16' booth.

# HANGING BANNER 12 FT SQUARE 8 IN



## Product Features

The Square Hanging Banner is a must have at your next trade show. These extra large hanging banners are produced from high quality fabric and enable you to be seen from practically anywhere at your trade show.

Graphic Size 576"W x 50"H  
(includes 2 inches of bleed for height)

Display Size 12' Deep x 12'W x 48" H

## Finishing

Hem with zipper

Printing Material Fabric

## Construction

All aluminum frame construction

## Weights - Dimensions

Shipping Weight 44 lbs

Shipping Dimensions 72" x 17" x 9"







## Graphic Specification

576"W x 50"H (includes 2 inches of bleed for height)

## Graphic Turnaround Time

Standard : 10 business days

## Parts List

	
(10) Chain	(56) Spring
	
(4) Small Tube	(8) Corner Connector
	
(16) Large Tube	
	
(8) Curved Stabilizer	
	
(1) Nylon Travel Bag	
	
(8) Tube Connector	(4) Eye Hook
	
(20) Large Screw	(10) Hook Loop Lock
	
(1) Screw Tightener	(1) Cable - 15 M

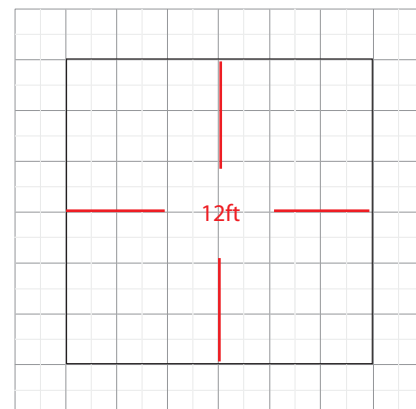

The box represents 16'x16' booth.

# HANGING BANNER 15 FT SQUARE 16 IN



## Product Features

The Square Hanging Banner is a must have at your next trade show. These extra large hanging banners are produced from high quality fabric and enable you to be seen from practically anywhere at your trade show.

Graphic Size 720"W x 26"H  
(includes 2 inches of bleed for height)

Display Size 15' Deep x 15'W x 24" H

## Finishing

Hem with zipper

Printing Material Fabric

## Construction

All aluminum frame construction

## Weights - Dimensions

Shipping Weight

Shipping Dimensions 72" x 17" x 9"

## Graphic Specification

720"W x 26"H (includes 2 inches of bleed for height)

## Graphic Turnaround Time

Standard : 10 business days

## Parts List

	
(10) Chain	(64) Spring
	
(4) Small Tube	(8) Corner Connector
	
(16) Large Tube	
	
(12) Curved Stabilizer	
	
(1) Nylon Travel Bag	
	
(8) Tube Connector	(4) Eye Hook
	
(28) Large Screw	(10) Hook Loop Lock
	
(1) Screw Tightener	(1) Cable - 16.5 M

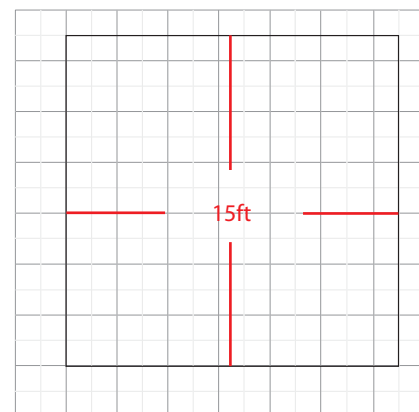

The box represents 16'x16' booth.

# HANGING BANNER FT SQUARE 3 IN



## Product Features

The Square Hanging Banner is a must have at your next trade show. These extra large hanging banners are produced from high quality fabric and enable you to be seen from practically anywhere at your trade show.

Graphic Size 720"W x 34"H  
(includes 2 inches of bleed for height)

Display Size 15' Deep x 15'W x 32" H

## Finishing

Hem with zipper

Printing Material Fabric

## Construction

All aluminum frame construction

## Weights - Dimensions

Shipping Weight

Shipping Dimensions 72" x 17" x 9"

## Graphic Specification

720"W x 34"H (includes 2 inches of bleed for height)

## Graphic Turnaround Time

Standard : 10 business days

## Parts List

	
(10) Chain	(64) Spring
	
(4) Small Tube	(8) Corner Connector
	
(16) Large Tube	
	
(12) Curved Stabilizer	
	
(1) Nylon Travel Bag	
	
(8) Tube Connector	(4) Eye Hook
	
(28) Large Screw	(10) Hook Loop Lock
	
(1) Screw Tightener	(1) Cable - 16.5 M

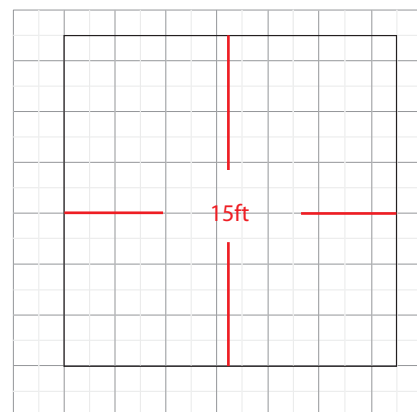

The box represents 16'x16' booth.

# HANGING BANNER

# FT SQUARE 36 IN



### Product Features

The Square Hanging Banner is a must have at your next trade show. These extra large hanging banners are produced from high quality fabric and enable you to be seen from practically anywhere at your trade show.

Graphic Size	720"W x 38"H (includes 2inches of bleed for height)
Display Size	15' Deep x 15'W x 36" H

### Finishing

Hem with zipper

Printing Material	Fabric
-------------------	--------

### Construction

All aluminum frame construction

### Weights - Dimensions

Shipping Weight	
Shipping Dimensions	72" x 17" x 9"







### Graphic Specification

720"W x 38"H (includes 2inches of bleed for height)

### Graphic Turnaround Time

Standard : 10 business days

### Parts List

	
(10) Chain	(64) Spring
	
(4) Small Tube	(8) Corner Connector
	
(16) Large Tube	
	
(12) Curved Stabilizer	
	
(1) Nylon Travel Bag	
	
(8) Tube Connector	(4) Eye Hook
	
(28) Large Screw	(10) Hook Loop Lock
	
(1) Screw Tightener	(1) Cable - 16.5 M

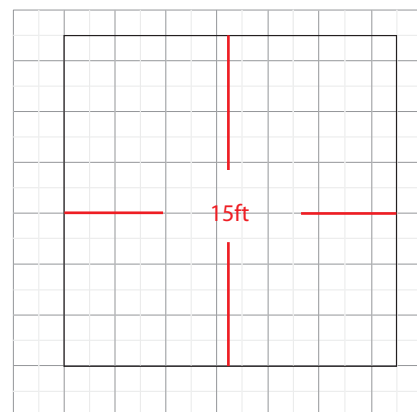

The box represents 16'x16' booth.

# HANGING BANNER 15 FT SQUARE 8 IN



## Product Features

The Square Hanging Banner is a must have at your next trade show. These extra large hanging banners are produced from high quality fabric and enable you to be seen from practically anywhere at your trade show.

Graphic Size 720"W x 50"H  
(includes 2 inches of bleed for height)

Display Size 15' Deep x 15'W x 48" H

## Finishing

Hem with zipper

Printing Material Fabric

## Construction

All aluminum frame construction

## Weights - Dimensions

Shipping Weight 49 lbs

Shipping Dimensions 72" x 17" x 9"





## Graphic Specification

720"W x 50"H (includes 2 inches of bleed for height)

## Graphic Turnaround Time

Standard : 10 business days

## Parts List

	
(10) Chain	(64) Spring
	
(4) Small Tube	(8) Corner Connector
	
(16) Large Tube	
	
(12) Curved Stabilizer	
	
(1) Nylon Travel Bag	
	
(8) Tube Connector	(4) Eye Hook
	
(28) Large Screw	(10) Hook Loop Lock
	
(1) Screw Tightener	(1) Cable - 16.5 M

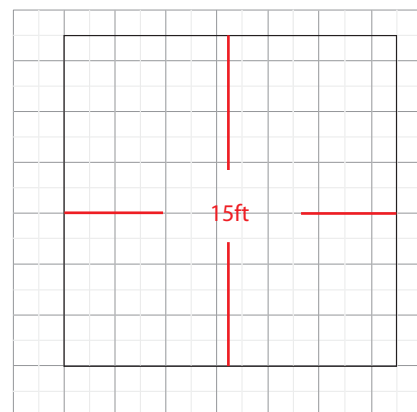

The box represents 16'x16' booth.